







	19°		1404 mm		2527 mm			
	1300 kg		327 kg		973 kg		1880 mm		4163 mm		2003 mm



ZNACZENIE IKON / THE MEANING OF THE ICONS BEDEUTUNG VON SYMBOLEN / LA SIGNIFICATION DES ICÔNES



Dopuszczalna masa całkowita [kg]
Gross vehicle weight [kg]
Zulässiges Gesamtgewicht [kg]
Poids total autorisé en charge [kg]

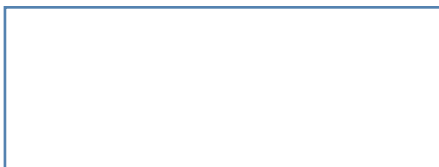
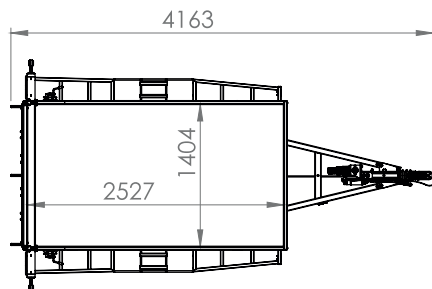
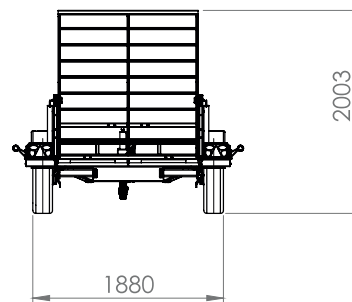
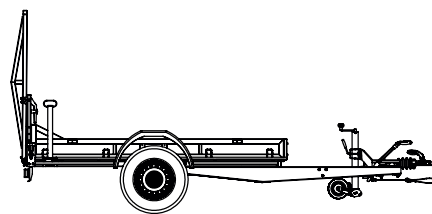

Ładowność [kg]
Load capacity [kg]
Nutzlast [kg]
Charge utile [kg]



Masa własna [kg]
Complete kerb weight [kg]
Leergewicht [kg]
Poids à vide [kg]



Rodzaj osi: Hamowana
Axles type: Braked
Typ der Achse: Gebremst
Type d'essieux: Freiné



Rodzaj kół
Wheels type
Typ der Räder
Type de roues



Liczba osi [sztuk]
Number of axles
Anzahl der Achsen
Nombre d'essieux



Kąt najazdu
Drive-on angle
Neigungswinkel
Angle d'attaque



Szerokość
Width
Breite
Largeur



Długość
Length
Länge
Longueur



Wysokość
Height
Höhe
Hauteur



Maksymalna długość powierzchni załadunku [mm]
Maximum length of the loading surface [mm]
Maximale Länge der Ladefläche [mm]
Longueur maximale de la surface de chargement [mm]



Maksymalna szerokość powierzchni załadunku [mm]
Maximum width of the loading surface [mm]
Maximale Breite der Ladefläche [mm]
Largeur maximale de la surface de chargement [mm]



WYPOSAŻENIE STANDARDOWE / STANDARD EQUIPMENT STANDARD AUSRÜSTUNG / ÉQUIPEMENT STANDARD



Hamulec najazdowy
Overrun brake
Auflaufbremse
Frein à inertie



Hamulec postojowy
Parking brake
Feststellbremse
Frein de stationnement



Koło podporowe
Support wheel
Stützrad
Roue jockey



Uchwyty mocowane do ramy przyczepy
Brackets for fixing load mounted in the trailer frame
Am Anhängerrahmen befestigte
Ladungssicherungsösen
Crochets pour fixation de la charge,
fixés sur le châssis de la remorque



Wodoodporna i antypoślizgowa sklejka
podłogowa
Waterproof and non-slip floor plywood
Wasserfestes und rutschfestes Bodensperholz
Plancher en contreplaqué imperméable
et antidérapant



Płukanie bębnow
Rinsing the drums
Trommeln spülen
Rinçage des tambours



Podpory załadunkowe
Loading supports
Stützen laden
Supports de chargement



Blokada trapu najazdowego
Overrun gangway lock
Sperrung für die Auffahrrampe
Blocage de la rampe de chargement



WYPOSAŻENIE DODATKOWE / ADDITIONAL EQUIPMENT OPTIONALES ZUBEHÖR / ÉQUIPEMENT SUPPLÉMENTAIRE



Mocowanie koła zapasowego
Spare wheel mounting
Ersatzrad-Befestigung
Fixation de la roue de secours



Zabezpieczenie antykradzieżowe
Anti-theft protection
Diebstahlschutz
Protection antivol



Koło zapasowe
Spare wheel
Ersatzrad
Roue de secours



Felgi aluminiowe
Aluminum rims
Aluminiumfelgen
jantes en aluminium



Tyłne lampy LED
LED rear lamps
LED-Heckleuchten
Feux LED arrière